

Мощный светодиод ARPL-50W-EPA-5060-WW (1750mA)

Features:

- More energy efficient than incandescent
and most halogen lamps
- low voltage operation
- Instant light
- Long operating life
- Anti UV

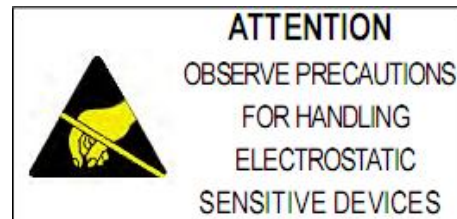

Applications:

- Indoor lighting:
spot light, ceiling light, bulb.....
- Architectural and landscape lighting:
down light, wall lamp, garden light
- Roadway lighting:
Street light, garden light, tunnel light
- Display lighting:

■ Package Dimensions

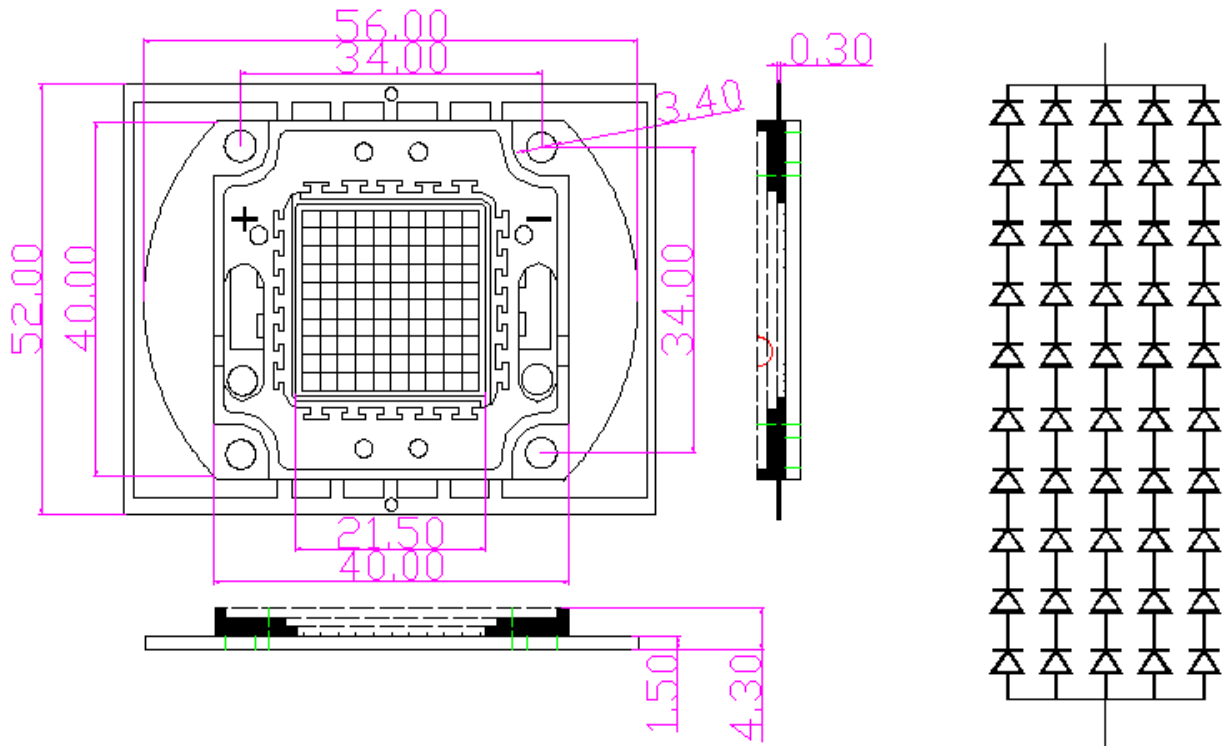

Notes: All dimensions in mm tolerance is ± 0.1 mm unless otherwise noted.

■ Radiation Diagram

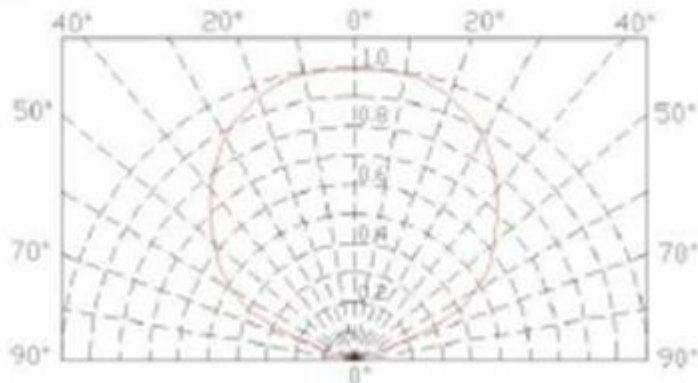

■ Absolute Maximum Ratings (Ta=25°C)

Parameter	Symbol	Rating	Unit
DC Forward Current	I_F	1750	mA
Peak pulse Current*	I_{FP}	2500	mA
Reverse Voltage	V_R	50	V
Power Dissipation	P_D	50	W
Operating Temperature Range	T_{OPR}	-30 ~ +75	°C
Storage Temperature Range	T_{STG}	-40 ~ +85	°C
LED Junction Temperature	T_J	125	°C

Notes: 1. 1/10 Duty Cycle 0.1ms Pulse Width.

■ Electrical/Optical Characteristics--White (At TA=25°C)

Parameter	Symbol	Conditions	Min	Avg.	Max	Units
Forward Voltage	V_F	$I_F=1750mA$	30.00	--	34.00	V
Thermal Resistance Junction To Board	$R\theta_{J-B}$	$I_F=1750mA$	--	10	--	°C/W
Luminous Flux	Φ_v	$I_F=1750mA$	4500		5000	lm
Color Temperature	CCT	$I_F=1750mA$	3000		3200	K
CRI	Ra	$I_F=1750mA$	60	--	--	--
Temperature Coefficient of Forward Voltage	$\Delta V_F/\Delta T$	$I_F=1750mA$	--	-2	--	mV/°C
Reverse Current	I_R	$V_R=50V$	--	--	10	μA
Viewing Angle ^[1]	$2\theta_{1/2}$	$I_F=1750mA$	--	120	--	Deg

■ Color & binning

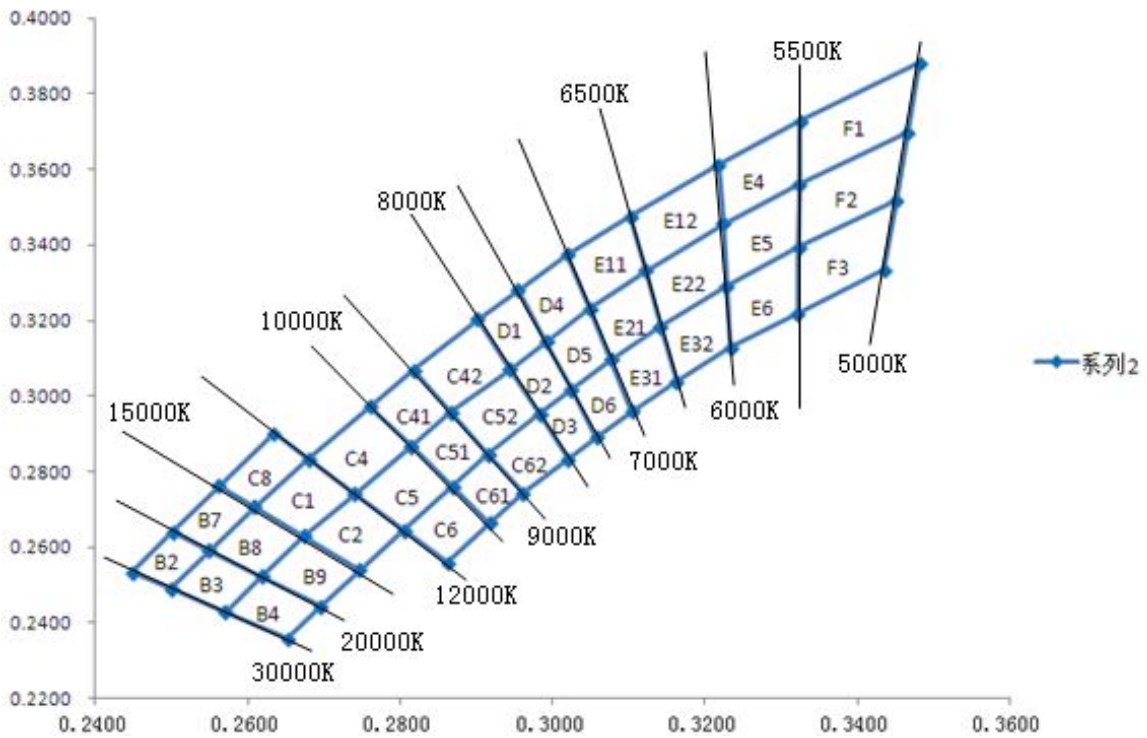
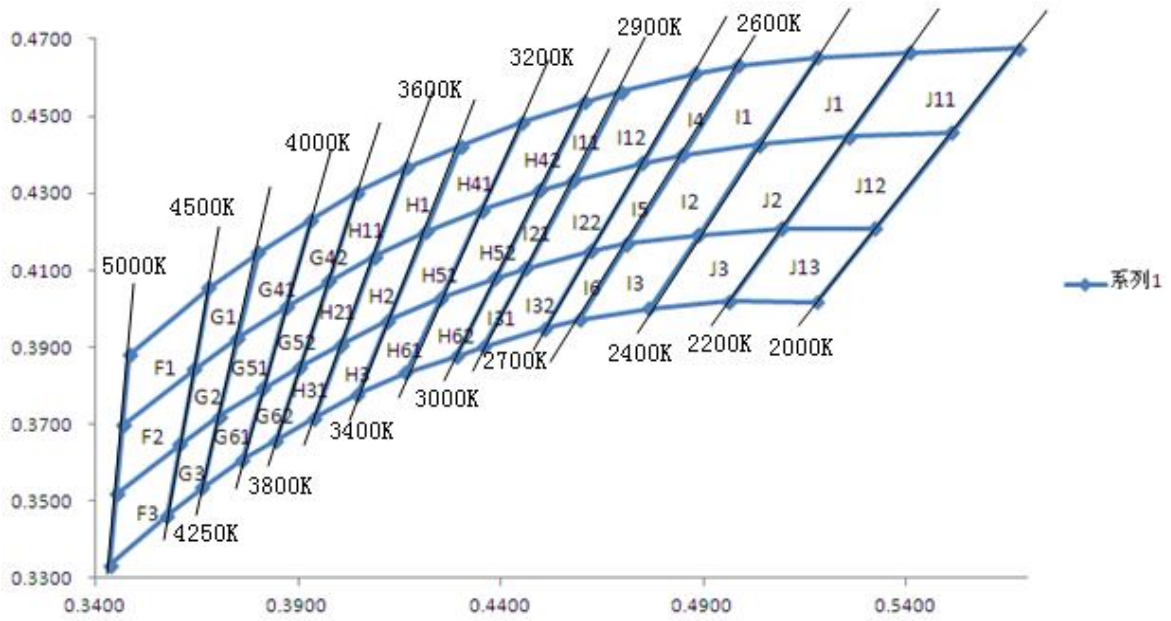

J11	0.5409	0.4666	J12	0.5258	0.4447	J13	0.5093	0.4209
	0.5677	0.4675		0.5513	0.4458		0.5323	0.4208
	0.5513	0.4458		0.5323	0.4208		0.5179	0.4018
	0.5258	0.4447		0.5093	0.4209		0.4963	0.4020
J1	0.5180	0.4653	J2	0.5036	0.4426	J3	0.4888	0.4192
	0.5409	0.4666		0.5258	0.4447		0.5093	0.4209
	0.5258	0.4447		0.5093	0.4209		0.4963	0.4020
	0.5036	0.4426		0.4888	0.4192		0.4766	0.4001
I1	0.4988	0.4632	I2	0.4849	0.4399	I3	0.4711	0.4169
	0.5180	0.4653		0.5036	0.4426		0.4888	0.4192
	0.5036	0.4426		0.4888	0.4192		0.4766	0.4001
	0.4849	0.4399		0.4711	0.4169		0.4593	0.3972
I4	0.4880	0.4611	I5	0.4750	0.4379	I6	0.4622	0.4150
	0.4988	0.4632		0.4849	0.4399		0.4711	0.4169
	0.4849	0.4399		0.4711	0.4169		0.4593	0.3972
	0.4750	0.4379		0.4622	0.4150		0.4509	0.3948
I12	0.4697	0.4563	I22	0.4579	0.4334	I32	0.4461	0.4104
	0.4880	0.4611		0.4750	0.4379		0.4622	0.4150
	0.4750	0.4379		0.4622	0.4150		0.4509	0.3948
	0.4579	0.4334		0.4461	0.4104		0.4357	0.3901
I11	0.4605	0.4536	I21	0.4496	0.4308	I31	0.4386	0.4080
	0.4697	0.4563		0.4579	0.4334		0.4461	0.4104
	0.4579	0.4334		0.4461	0.4104		0.4357	0.3901
	0.4496	0.4308		0.4386	0.4080		0.4289	0.3877
H42	0.4454	0.4484	H52	0.4353	0.4257	H62	0.4251	0.4028
	0.4605	0.4536		0.4496	0.4308		0.4386	0.4080
	0.4496	0.4308		0.4386	0.4080		0.4289	0.3877
	0.4353	0.4257		0.4251	0.4028		0.4164	0.3834
H41	0.4302	0.4423	H51	0.4214	0.4200	H61	0.4122	0.3969
	0.4454	0.4484		0.4353	0.4257		0.4251	0.4028
	0.4353	0.4257		0.4251	0.4028		0.4164	0.3834
	0.4214	0.4200		0.4122	0.3969		0.4047	0.3779

H1	0.4167	0.4366	H2	0.4087	0.4136	H3	0.4007	0.3908
	0.4302	0.4423		0.4214	0.4200		0.4122	0.3969
	0.4214	0.4200		0.4122	0.3969		0.4047	0.3779
	0.4087	0.4136		0.4007	0.3908		0.3940	0.3717
H11	0.4045	0.4301	H21	0.3974	0.4072	H31	0.3904	0.3850
	0.4167	0.4366		0.4087	0.4136		0.4007	0.3908
	0.4087	0.4136		0.4007	0.3908		0.3940	0.3717
	0.3974	0.4072		0.3904	0.3850		0.3845	0.3659
G42	0.3932	0.4232	G52	0.3870	0.4005	G62	0.3812	0.3793
	0.4045	0.4301		0.3974	0.4072		0.3904	0.3850
	0.3974	0.4072		0.3904	0.3850		0.3845	0.3659
	0.3870	0.4005		0.3812	0.3793		0.3761	0.3608
G41	0.3800	0.4146	G51	0.3750	0.3923	G61	0.3704	0.3720
	0.3932	0.4232		0.3870	0.4005		0.3812	0.3793
	0.3870	0.4005		0.3812	0.3793		0.3761	0.3608
	0.3750	0.3923		0.3704	0.3720		0.3662	0.3536
G1	0.3679	0.4055	G2	0.3642	0.3843	G3	0.3608	0.3648
	0.3800	0.4146		0.3750	0.3923		0.3704	0.3720
	0.3750	0.3923		0.3704	0.3720		0.3662	0.3536
	0.3642	0.3843		0.3608	0.3648		0.3576	0.3463
F4	0.3482	0.3881	F5	0.3466	0.3698	F6	0.3451	0.3519
	0.3679	0.4055		0.3642	0.3843		0.3608	0.3648
	0.3642	0.3843		0.3608	0.3648		0.3576	0.3463
	0.3466	0.3698		0.3451	0.3519		0.3435	0.3335

F1	0.3325	0.3728	F2	0.3324	0.3560	F3	0.3323	0.3394
	0.3482	0.3881		0.3466	0.3698		0.3451	0.3519
	0.3466	0.3698		0.3451	0.3519		0.3435	0.3335
	0.3324	0.3560		0.3323	0.3394		0.3322	0.3219
E4	0.3218	0.3613	E5	0.3224	0.3456	E6	0.3229	0.3291
	0.3325	0.3728		0.3324	0.3560		0.3323	0.3394
	0.3324	0.3560		0.3323	0.3394		0.3322	0.3219
	0.3224	0.3456		0.3229	0.3291		0.3234	0.3129
E12	0.3102	0.3475	E22	0.3122	0.3332	E32	0.3142	0.3184
	0.3218	0.3613		0.3224	0.3456		0.3229	0.3291

	0.3224	0.3456		0.3229	0.3291		0.3234	0.3129
	0.3122	0.3332		0.3142	0.3184		0.3163	0.3038
E11	0.3020	0.3374	E21	0.3049	0.3232	E31	0.3077	0.3096
	0.3102	0.3475		0.3122	0.3332		0.3142	0.3184
	0.3122	0.3332		0.3142	0.3184		0.3163	0.3038
	0.3049	0.3232		0.3077	0.3096		0.3104	0.2960
D4	0.2955	0.3281	D5	0.2992	0.3143	D6	0.3025	0.3018
	0.3020	0.3374		0.3049	0.3232		0.3077	0.3096
	0.3049	0.3232		0.3077	0.3096		0.3104	0.2960
	0.2992	0.3143		0.3025	0.3018		0.3058	0.2892

D1	0.2902	0.3203	D2	0.2944	0.3070	D3	0.2983	0.2952
	0.2955	0.3281		0.2992	0.3143		0.3025	0.3018
	0.2992	0.3143		0.3025	0.3018		0.3058	0.2892
	0.2944	0.3070		0.2983	0.2952		0.3021	0.2833
C42	0.2818	0.3069	C52	0.2867	0.2957	C62	0.2916	0.2846
	0.2902	0.3203		0.2944	0.3070		0.2983	0.2952
	0.2944	0.3070		0.2983	0.2952		0.3021	0.2833
	0.2867	0.2957		0.2916	0.2846		0.2961	0.2744
C41	0.2761	0.2972	C51	0.2815	0.2868	C61	0.2869	0.2761
	0.2818	0.3069		0.2867	0.2957		0.2916	0.2846
	0.2867	0.2957		0.2916	0.2846		0.2961	0.2744
	0.2815	0.2868		0.2869	0.2761		0.2918	0.2665
C4	0.2680	0.2833	C5	0.2740	0.2742	C6	0.2805	0.2645
	0.2761	0.2972		0.2815	0.2868		0.2869	0.2761
	0.2815	0.2868		0.2869	0.2761		0.2918	0.2665
	0.2740	0.2742		0.2805	0.2645		0.2862	0.2559
C8	0.2562	0.2762	C1	0.2609	0.2706	C2	0.2673	0.2629
	0.2634	0.2902		0.2680	0.2833		0.2740	0.2742
	0.2680	0.2833		0.2740	0.2742		0.2805	0.2645
	0.2609	0.2706		0.2673	0.2629		0.2747	0.2540
B7	0.2502	0.2641	B8	0.2549	0.2592	B9	0.2618	0.2522
	0.2562	0.2762		0.2609	0.2706		0.2673	0.2629
	0.2609	0.2706		0.2673	0.2629		0.2747	0.2540
	0.2549	0.2592		0.2618	0.2522		0.2696	0.2443

■ Typical Optical/Electrical Characteristics Curves
($T_a=25^\circ\text{C}$ Unless Otherwise Noted)

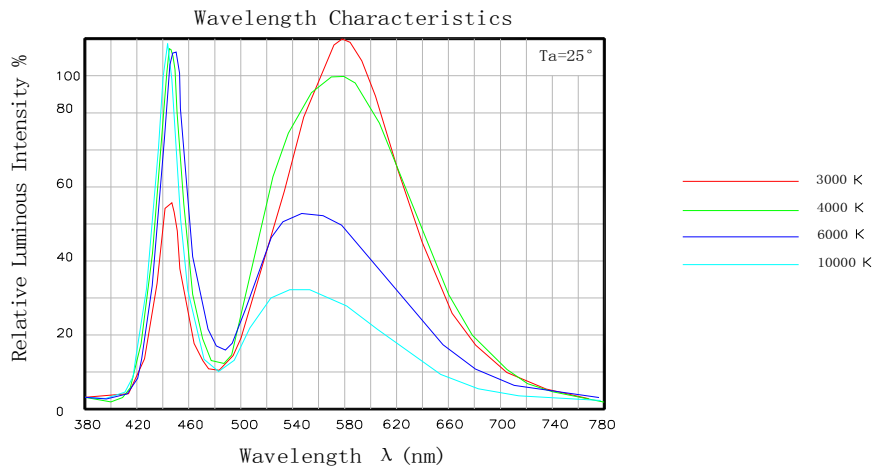
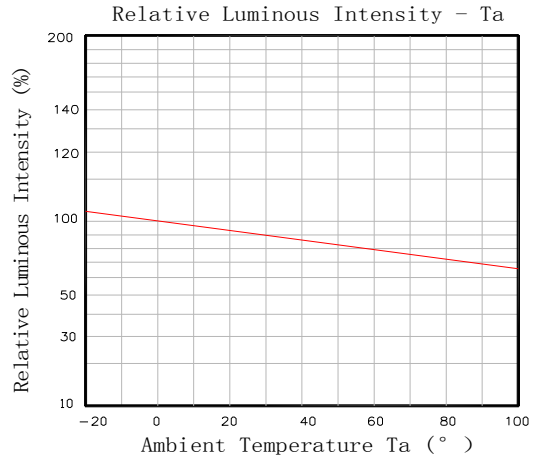
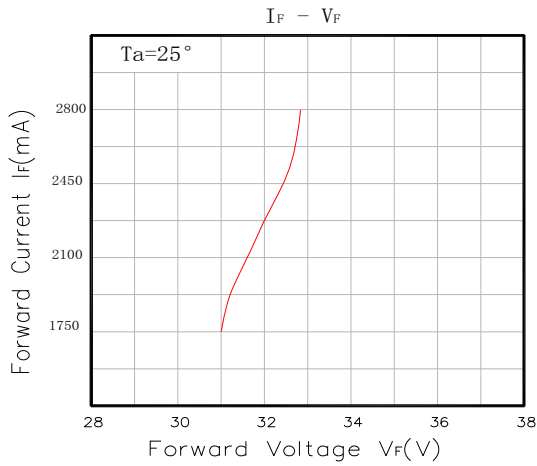
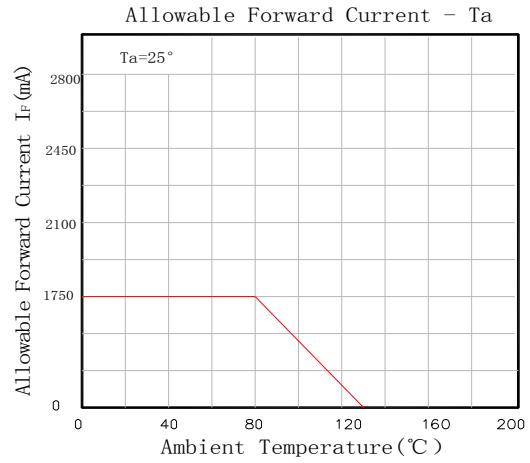
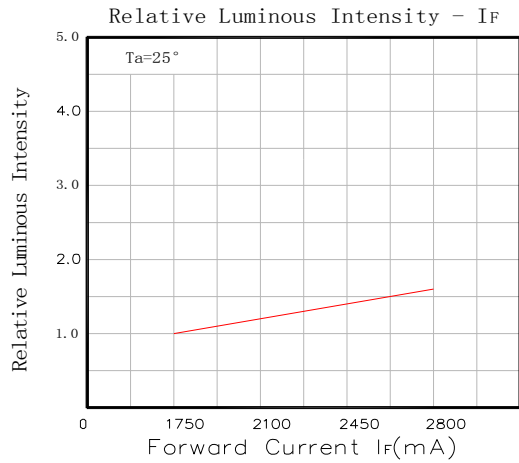

■ Reliability test standards

Type	Test Item	REF. Standard	Test condition	Duration	Sample count	Accept
	Temperature Cycle	JESD22-A104-A	-40°C~25°C~100°C~25°C 30min,5min,30min,5min	100 100 cycles	22	0/22
	Thermal shock	JESD22-A106	-40°C~100°C 30min, 30min	100 100 cycles	22	0/22
	High Temperature Storage	JEITA ED-4701 200 201	Ta=100°C ± 5°C	1000 Hrs	22	0/22
	Low Temperature Storage	JEITA ED-4701 200 202	Ta=-40°C ± 5°C	1000 Hrs	22	0/22
	Humidity Heat Storage	JIS C 7021 (1977)B-11	Ta=60°C RH=85%	1000Hrs	22	0/22
	Life test	JESD22-A108-A	Ta=25°C If=1750mA	1000Hrs	22	0/22
	High humidity Heat life test	JESD22-A101	Ta=60°C RH=85% IF=1750mA	1000Hrs	22	0/22
	Resistance to soldering Heat	JESD22-A113	IR soldering 245°C/10sec	1 time	20	0/22

Precautions for use

1. Storage

- (1) The best Storage environment: temperature :5°C~30°C , Humidity:40% -80%HR
- (2) LED store after six months to be re-spectral color separation, to prevent the LED optical properties change

2. Production and application

- (1) need wear gloves when contact with led to prevent oxidation
- (2) ESD protection to be good
- (3) soldering: the pc type can use soldering iron, (the best temperature is 300°C/3sec) also can use Temperature Platform (150°C/30sec,max) the silicone type can use reflow soldering in addition to soldering iron and Temperature Platform
- (4) about Package-type silicone , It is recommended to bake before soldering when the pack is unsealed after 24h. The conditions are as following: 80°C 4-6h.
- (5) must have a good heat sinking, the temperature of the heat sink must be below 65 degree

3. Relow temp/time

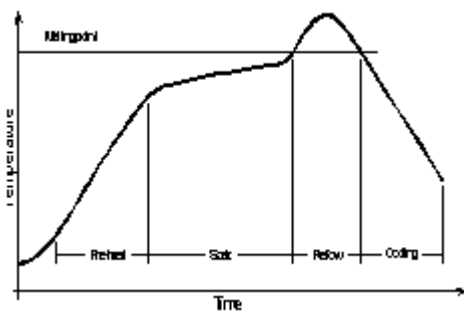

Solder = Low-temperature lead-free solder	Solder = Lead-free solder
Slope of the temperature rise = Max. 4°C/sec.	Slope of the temperature rise = Max. 4°C/sec.
Preheating temperature = 100°C ~ 150°C	Preheating temperature = 150°C ~ 180°C
Preheating time = Max. 60 sec.	Preheating time = Max. 90 sec.
Slope of the temperature drop = Max. 6°C/sec.	Slope of the temperature drop = Max. 6°C/sec.
Peak temperature = Max. 180°C	Peak temperature = Max. 220°C
The time of peak temperature ($\pm 5^{\circ}\text{C}$) should not exceed 10 sec.	The time of peak temperature ($\pm 5^{\circ}\text{C}$) should not exceed 10 sec.
The time of temperature rise of 160°C should not exceed 60 sec.	The time of temperature rise of 160°C should not exceed 60 sec.